

EXTERIOR

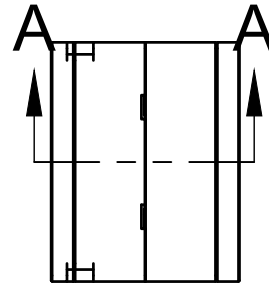

CAVITY

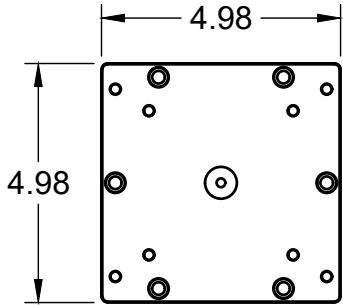
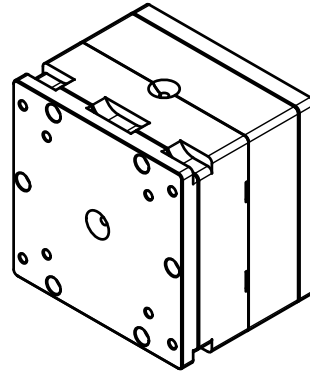
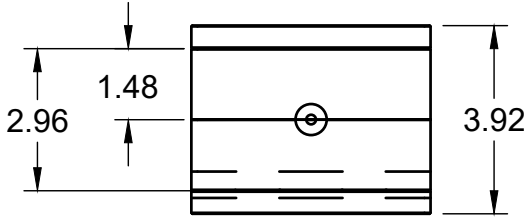
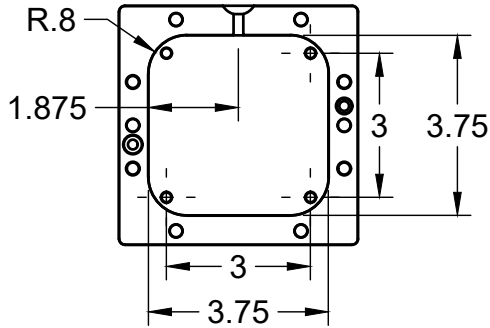

SECTION A-A

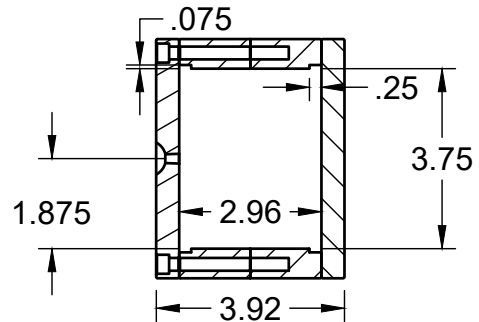

All dimensions are in inches

PROJECT

Mold Frame MFC505040

TITLE

Mold Frame 5x5x4 Assembly

APPROVED

SIZE

CODE

DWG NO

REV

CHECKED

A

DRAWN

4/3/2023

SCALE 1:4

WEIGHT

SHEET 1/4